

User Manual

EASY3DMAKER



Table of Contents

1	General References	4
2	Intended use.....	5
3	IMPORTANT SAFETY NOTICES	5
4	INSTALLATION INSTRUCTIONS	7
5	Initial start-up.....	7
5.1	Packaging content	7
5.2	Description of the axes and of the components	8
5.3	Positioning.....	8
5.4	Adjustment of the printing bed	9
5.5	Printing materials	10
5.6	Inserting the material	11
5.7	Adjusting the pressing force.....	14
5.8	Changing the material	14
5.8.1	The same material and the same color	14
5.8.2	Different material or different color	15
6	Printing.....	16
6.1	Preparations before printing.....	16
6.2	Cleaning the printing bed	16
6.3	Preparing the printing bed for printing.....	17
6.4	Starting the print	17
6.4.1	With the connected PC.....	17
6.4.2	From the SD-card.....	17
6.5	Removing the printed object.....	17
7	Cleaning and maintenance.....	18

7.1	Nozzle	18
7.2	Housing.....	19
7.3	Guidings.....	19
8	Problems regarding the print.....	19
9	Warranty	19
10	Disposal notes	20
11	Contact details.....	20

1 General References

Thank you a lot for purchasing our 3D-printer.

Please read this instruction carefully before the first start-up and handling with the printer.

This device conforms the applicable European standards.
You can find the declaration of conformity as an attachment of this user manual.



Don't dispose this device with the usual domestic waste.
Please regard the chapter 'Notes of disposal'.



This manual contains references to the software "3Dfactories Repetier-Host(V1.0.6)", which is described in another user manual. The software and the corresponding user manual are contained on the CD, which is attached to the delivered 3D-printer.

In the corresponding fields of the program can be entered digits and decimal digits. The decimal digits are not represented by a comma, but by a point (e. g. 0.5). The numbers are entered in the corresponding fields principally without the indication of the units.

The units (e.g. mm/s, °C, %) are situated near the fields in which the digits or the decimal digits have to be entered.

This manual has been written with an explicit accuracy. For printing and translating errors there cannot be assumed any liability. 3Dfactories by Adolf Fenz GmbH assumes no liability for damages which occur by the use of this product.

3Dfactories by Adolf Fenz GmbH reserves its right to change the properties of the printers and the software which are described in this manual, at any time.

The reprint, even the partial reproduction of this documentation needs the explicit approval from 3Dfactories by Adolf Fenz GmbH.

The fascinating technology of the 3D-print enables you multiple possibilities. A diversification of the printing result is possible every time by changing single parameters. The quality of your print depends on various parameters and it also depends decisively on the environmental conditions and the used materials. Because of this it is unfortunately not possible to guarantee a constant good quality of the printing results.

2 Intended use

This device is designed for generating three-dimensional objects, which consist of plastic.

By doing this, plastic, which has the shape of a solid strand, is heated up in the device until it passes to the liquid state. The liquid plastic is applied by a nozzle in layers on a printing bed. The layers, which are lying on each other, are shaping the plastic object.

After the printing process has been ended, the plastic object can be removed from the printing bed.

The device must be used exclusively for this purpose.

Such kind of plastic objects are used for manufacturing of prototypes and models or in the private sector.

Each other imaginable use of the device, which differs from the one described in this chapter, represents a misapplication, which we strongly disapprove.

The misuse of this device may cause significant damages to persons or to the environment.

For the possible consequences, which may be caused by the misapplication of the device, always the person is liable, that directly causes or induces the misapplication.

The producer cannot be made liable or responsible for any consequences or damages, which occur by the misuse of this device.

3 IMPORTANT SAFETY NOTICES

- Damages of the printer, caused by not regarding this user manual, lead to the expiration of the guarantee claims.
- For material damages and injuries which are caused by incorrect operations or disregarding this user manual, the user is responsible, the manufacturer 3Dfactories by Adolf Fenz GmbH cannot be made liable therefore.
- **ATTENTION, DANGER OF BURNING. DO NOT TOUCH HOT PARTS AS THE EXTRUDER, THE NOZZLE OR THE HEATABLE PRINTING BED. BE CAREFUL!**
- **TURN OFF THE HEATING OF THE PRINTING BED DURING MAINTAINING OR CLEANING THE PRINTER. ALTERNATIVELY YOU CAN ALSO SET THE TEMPERATURE OF THE PRINTING BED ON 20°C.**
- **THIS DEVICE IS NOT A TOY. DON'T LET CHILDREN UNSUPERVISED WITH THIS DEVICE.**
- **DON'T GRAB INTO THE WORKING SPACE OF THE RUNNING DEVICE, CRUSHING HAZARD!**
- **DON'T ENABLE THE UNSUPERVISED OPERATION OF THIS MACHINE!**
- **ATTENTION, HOT PLACES OVER 70°C, DANGER OF BURNING!**

- PERSONS WHICH ARE PHYSICALLY OR MENTALLY UNABLE TO USE THE DEVICE OR UNABLE TO UNDERSTAND THE USER MANUAL ARE ALLOWED TO USE THIS MACHINE ONLY UNDER INSTRUCTION OR SUPERVISION OF A QUALIFIED PERSON!
- BEFORE STATING UP, PLEASE CHECK THE INTEGRITY AND THE FUNCTIONALITY OF THE DEVICE.
- RISK OF ELECTRIC SHOCK!
- This device shall only be used by persons which are older than 18 years.



4 INSTALLATION INSTRUCTIONS

- POSITION THE PRINTER ON A DRY AND DUSTLESS PLACE.
- POSITION THE PRINTER ON A STABLE UNDERGROUND. A SWINGING UNDERGROUND INFLUENCES THE PRINTING RESULT NEGATIVELY.
- THE DEVICE SHOULD BE LOCATED IN ROOMS, WHICH ARE REGULARLY VENTILATED WITH FRESH AIR - EITHER BY A WINDOW VENTILATION, OR BY VENTILATION SYSTEMS.
- POSITIONING THE PRINTER ON LOCATIONS, WHERE FOOD IS CONSUMED, SHOULD BE AVOIDED.
- **CARE FOR A GOOD VENTILATION, USE IN SMALL ROOMS A FORCED VENTILATION.**
- POSITION THE PRINTER IN A SAFE DISTANCE TO FLAMMABLE OBJECTS (E.G. CURTAINS). THE PRINTER SHOULD NEVER GET IN CONTACT WITH FLUIDS.
- PROTECT THE PRINTER FROM DIRECT SOLAR RADIATION.
- DON'T EXPOSE THE PRINTER TO SEVERE TEMPERATURE FLUCTUATIONS.
- RECOMMENDED AMBIENT TEMPERATURE: 20°C TO 30°C
- DO NOT POSITION THE PRINTER IN THE IMMEDIATE VICINITY OF HEATERS, VENTILATION OR AIR CONDITIONING SYSTEMS.

5 Initial start-up

5.1 Packaging content

To avoid damaging the printer, please open the packaging carefully, in which you can find the following items:

- Printer EASY3DMAKER
- Power adapter 220 Volt/24 Volt
- Power cable
- USB cable
- CD containing software
- Scraper and hex key

5.2 Description of the axes and of the components

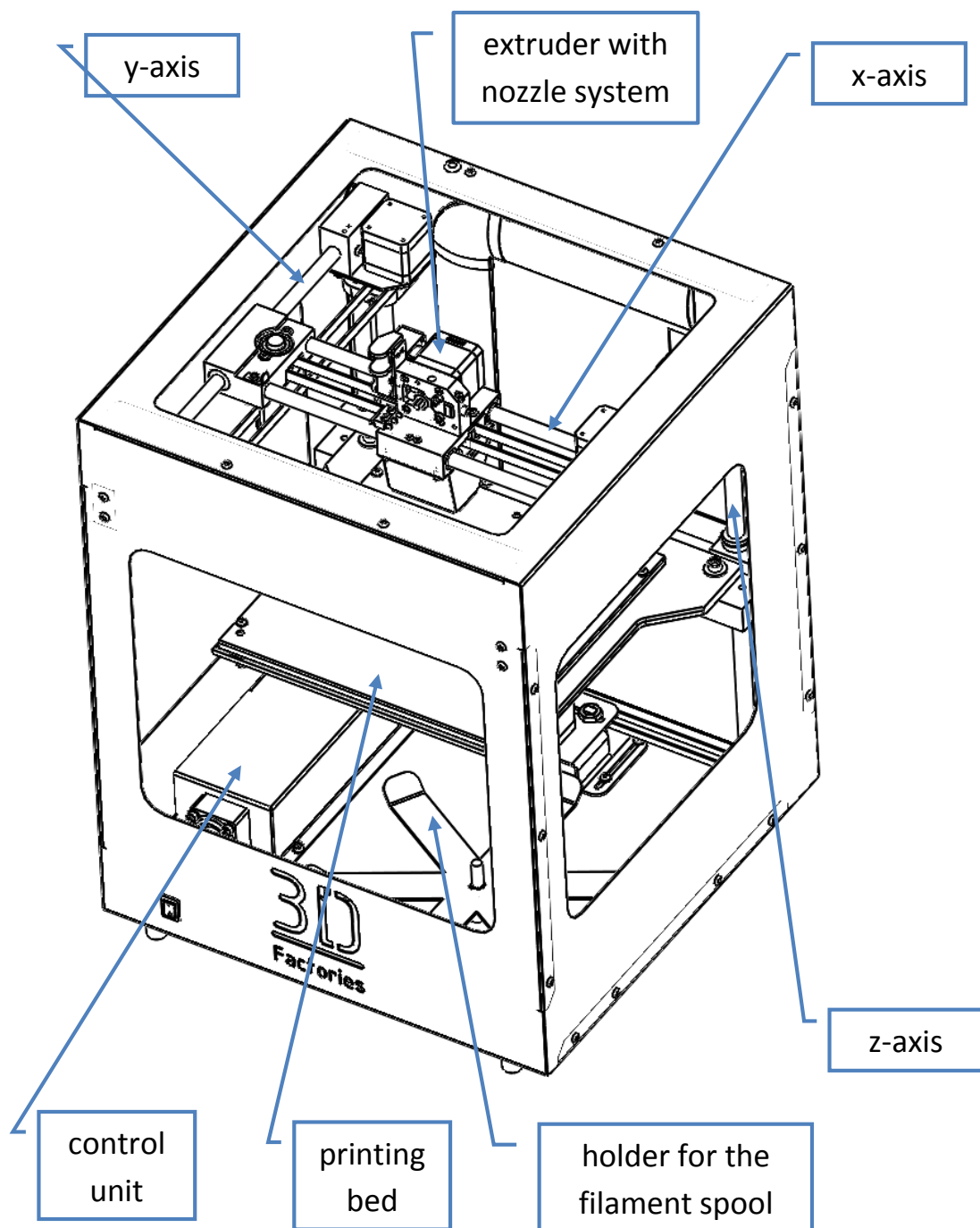

5.3 Positioning

Position the printer according to the positioning instructions. Remove all transport locks and make sure that especially the axes are movable.

You must install the delivered software before connecting the printer with the PC. Installation advices regarding the software you can find in the user manual of the software.

Plug the cable of the power adapter into the printer and connect the printer via USB-cable with the PC.



Turn the printer on.

The printer is now operational and can be controlled via the software.

5.4 Adjustment of the printing bed

Due to temperature and humidity variations during the transport, it is necessary to check the distance between the nozzle and the printing bed and adjust it, if necessary.

This procedure is very important for the durability of the printer and the printing quality.

Wrong adjustments can damage the nozzle and the printing bed!

Procedure:

1. Turn the printer on (Position I) and start the software
2. Connect the software with the printer
3. Choose the menu "Manual Control" in the right menu block
4. Lay a piece of paper 80 g/m² on the printing bed
5. After clicking the button  (referencing), the printer will go to the referencing position
6. **Turn the printer off**
7. Adjust the distance so, that the paper can be easily moved between the nozzle and the printing bed, but does not have clearance
Adjust the right distance with the help of the delivered hex key
8. Move the printing head to the positions shown on the picture and repeat the procedure.
The printing head should only be moved in the two horizontal axes X and Y by pulling smoothly and slowly the tooth belts.
During this procedure the vertical Z-axis should not be moved in any case!
9. Please do not damage the cables from the extruder
10. Now the distance should be identical on all points, the paper should easily be moved
11. Prove with a lineal or optically, if the printing bed is plane. If the printing bed has a curvature, than it should be changed.
12. Now the printer is operational

Reference:

**Under no circumstances the nozzle should touch the printing bed.
Repeat these steps after a longer standstill or a new positioning.**

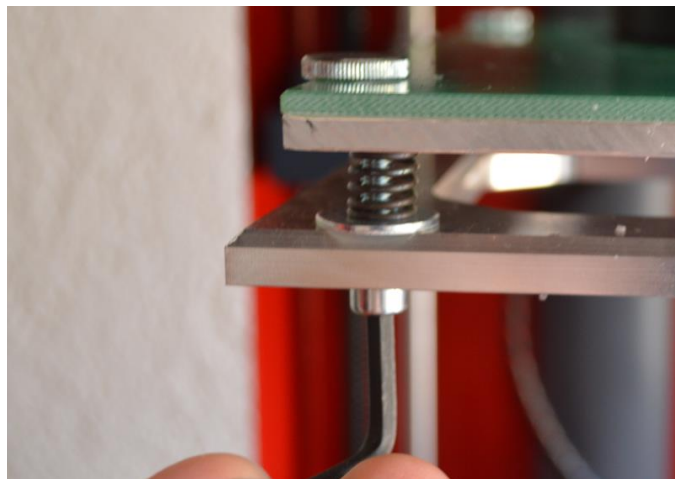
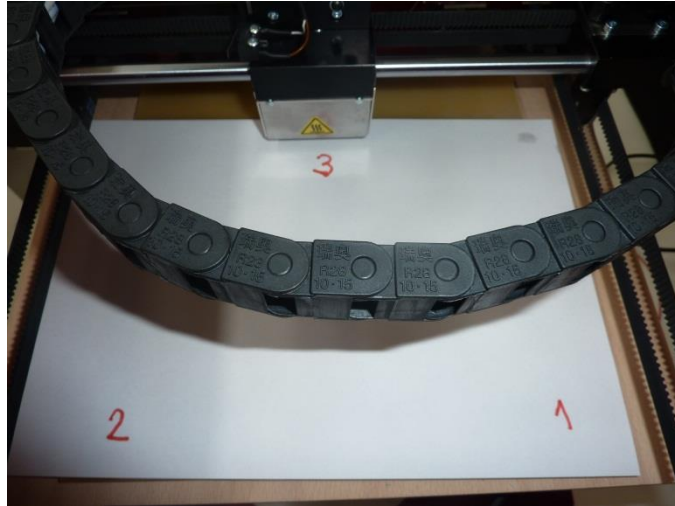

5.5 Printing materials

For printing you need the following materials:

- Filament (PLA or ABS) diameter 1,75 mm, on a spool
- Adhesive 3DGlue

All printing materials can be ordered from our distributors or from your dealer. In order to loosen the models from the printing bed and to clean the printing bed itself, you need a scraper, a cutter or a hob scraper.



5.6 Inserting the material

1. Pull the guiding tube from the top of the housing until the lower portion of the tube in the housing protrudes approximately only 5 cm.



2. Put the spool with the filament on the support from below the printing bed.
3. Cut a piece of the printer's packaging material and drag the filament through it before inserting the filament into the guiding tube.
This procedure reduces the amount of possible dirt particles on the filament and therefore also the risk of a blocked nozzle.



4. Push the filament strand through the white guiding tube till approximately 10 cm in front of the extruder.
5. Drag the white guiding tube out from the extruder (not necessary at the initial start-up, because the tube is not inserted ex works).
6. Push the filament further until it protrudes ca.10 cm from the guiding tube.
7. Cut off a small piece from the filament, so that the strand gets a smooth edge.

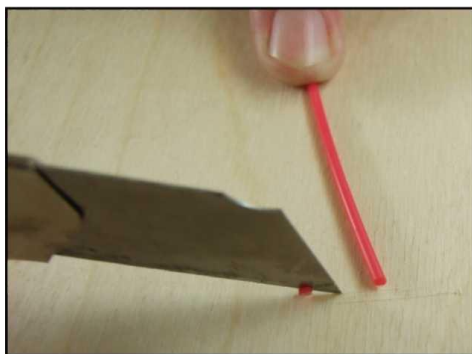

8. Turn the printer on (position I) and start the software.

9. Connect the software with the printer by pressing the button



10. Choose the menu "Manual Control" from the right menu block.

11. Set the value of the extruders temperature on 200°C when using PLA and on 240°C when using ABS.



12. Turn the heating of the extruder on in the software by clicking the button in the menu "Manual Control".



13. After the set temperature value is reached, press the key  of the extruder button



14. Slide the end of the filament between the two drive rolls, so that the filament can be retracted. Ensure that the filament is retracted straightly into the extruder.

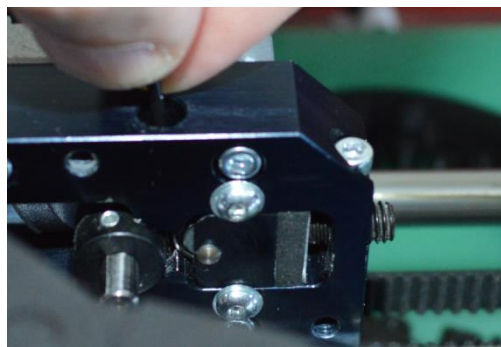

15. Repeat point 14 so long until the material flows steady from the nozzle.

16. Slide the white guiding tube again into the extruder.

17. Switch off the heating of the extruder by pressing the button  in the software menu and wait until the nozzle has cooled down.

18. Cut the extruded plastic on the hot end of the nozzle, after it cooled down. Attention, risk of burning!

5.7 Adjusting the pressing force

If the material transport should not be ideal, then the pressing force is either too small, (no material transport) or too high (driving wheel clatters).

Proceed in the following way:

Loosen the locking screw of the extruder. Adjust the hexagon socket screw, that the pressing wheel is pressing only smoothly against the material. Secure your adjustment by tightening the locking screw.

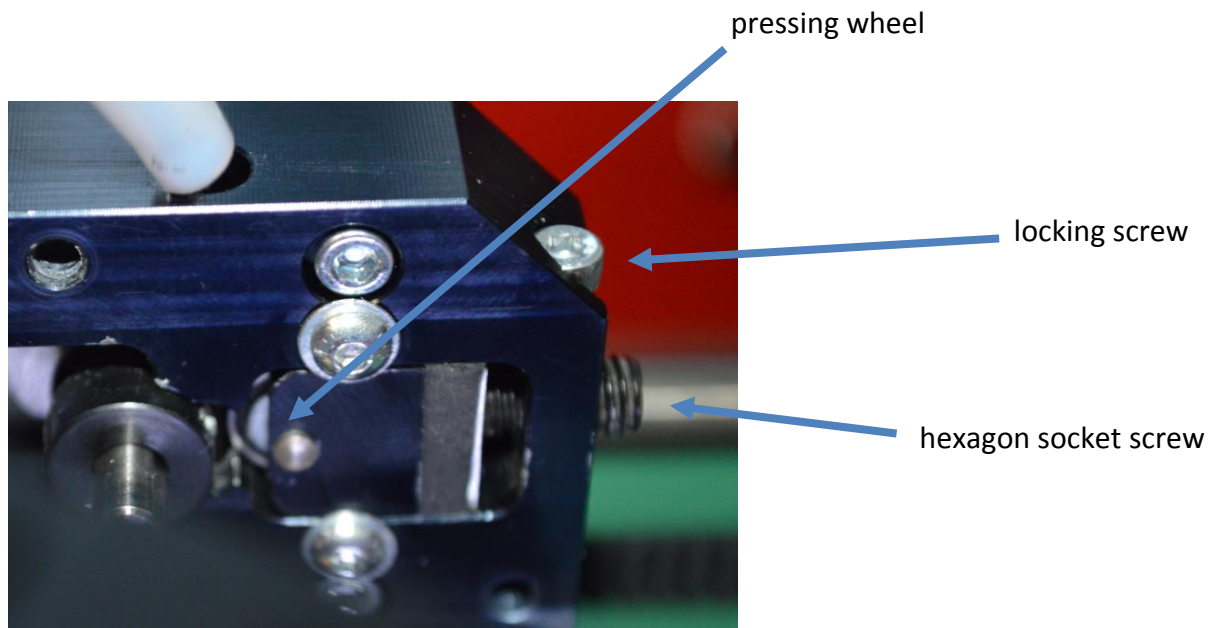

If the driving wheel clatters during the operation of the printer, please reduce the pressing force slightly. A pressing force which is too strong will lead to the squashing of the filament and stops so the inflow of the material into the extruder.

5.8 Changing the material

5.8.1 The same material and the same color

1. Pull out the white guiding tube from the extruder.
2. Cut the filament strand ca. 2 cm above the extruder.
3. Set the value of the extruder's temperature on 200°C for PLA und on 240°C for ABS.

- Switch on in the software menu the heating of the extruder by clicking on the button



in the menu "Manual Control".

- After the set temperature is reached, please press the key  of the extruder button



- Put the beginning of the new filament strand on the end of the old filament strand and insert the new filament strand equably into the extruder.
- After the new filament strand has been introduced into the extruder, the white guiding tube can be pushed back into the extruder.
- Switch off the heating of the extruder in the software menu by pressing the button



5.8.2 Different material or different color

- Pull out the white guiding tube from the extruder.
- Cut the filament strand ca. 2 cm above the extruder.
- Set the value of the extruder's temperature on 240°C in the case of changing the material (ABS to PLA or PLA to ABS), or, when using the same material, on 200°C for PLA and on 240°C for ABS.
- Switch on in the software menu the heating of the extruder by clicking on the button



in the menu "Manual Control".

- After the set temperature is reached, please press the key  of the extruder button



- Put the beginning of the new filament strand on the end of the old filament strand and insert the new filament strand equably into the extruder.
- After the new filament strand is introduced into the extruder, the white guiding tube can be pushed back into the extruder.

8. Repeat the procedure nr. 5 at least 2 times, until the new material flows without rests of the old material out of the nozzle. If necessary, you can repeat the procedure.

In order to increase the throughput rate of the extruder, the button  can be pressed

instead of the button .

The throughput rate of the printing material will be doubled.

9. Switch off the heating of the extruder in the software menu by pressing the button



Always use original materials in order to avoid damages on the printer!

6 Printing

6.1 Preparations before printing

Please consider the following points before printing:

- Make sure that the printing bed is clean
- Remove all remaining materials, if necessary
- Make sure that the printing bed is properly positioned and secured
- Make sure, that the nozzle is clean and free of remaining material
- Check the adjustment of the printing bed
- Make sure that the material was inserted correctly into the extruder and that the material spool can be moved freely on the rotary support

6.2 Cleaning the printing bed

Each printer is fully tested regarding the functionality before the delivery. Therefore it can happen that some rests of material or glue may be on the printing bed. This is not a defect, but rather a sign that the printer has been fully tested.

Make sure that before the initial start-up of the printer the printing bed is clean. Remove possible rests of material or glue with a knife, a scraper or a hob scraper. Remove them gently, in order to avoid damaging the printing surface. Slight grooves on the printing bed don't have normally effects on the quality of the printer. If the printing bed has deep grooves or scratches, you should replace it.

Clean the printing bed before each print by removing unnecessary plastic with the scraper.

Remnants of the 3D-Glue can be let on the printing bed. If the thickness of the remaining 3D-Glue from previous prints should be too large, it must be removed.

6.3 Preparing the printing bed for printing

We recommend the use of PLA as a printing material.

In order to guarantee a safe adhesion of the model on the printing bed, there must be used an adjuvant. You can do this by preparing the printing bed with our 3D-Glue. When models with a big ground area are printed out of ABS, the possibility of the loosening of the printed object from the printing bed consists, because of the properties of the material.

Therefore we recommend heating the printing bed when using ABS-filament.

6.4 Starting the print

6.4.1 With the connected PC

The print is controlled by the included software. For this software exists a separate user manual, in which the various possibilities of printing are described.



Attention: Do not grab into the cross section during the print!

6.4.2 From the SD-card

Generate the G-Code-file with the included software.

The explicit procedure regarding this is described in the user manual of the software.

Switch the printer off, insert the SD-Card into the card-reader and switch the printer on. Now the print will start automatically.

REMOVE THE SD-CARD AFTER THE PRINT, BECAUSE OTHERWISE THE SAME PRINT WILL START AGAIN AFTER THE PRINTER WILL BE SWITCHED ON.

EVEN AFTER A POWER BLACKOUT THE PRINT WILL START FROM THE BEGINNING. DON'T LET THE PRINTER UNATTENDED, IN ORDER TO AVOID DAMAGES ON THE DEVICE AND THE MODEL.

6.5 Removing the printed object

After the print is fully ended, the printing bed will move to the parking position. Switch the printer off and remove the printed model carefully. Loosen the connection between the model and the printing bed carefully with the help of a scraper or a knife.



7 Cleaning and maintenance

7.1 Nozzle

SAFETY INSTRUCTIONS!

- Switch the printer off and remove the power cable while doing any cleaning or maintenance work.
- Wait 30 minutes after the last print, before beginning any work on the nozzle. The nozzle can become hot up to 280°C!



- Do not touch the printing head, while the device is switched on. Danger of burning!

Make sure that the nozzle is clean and free of old material. If necessary, remove the old material.

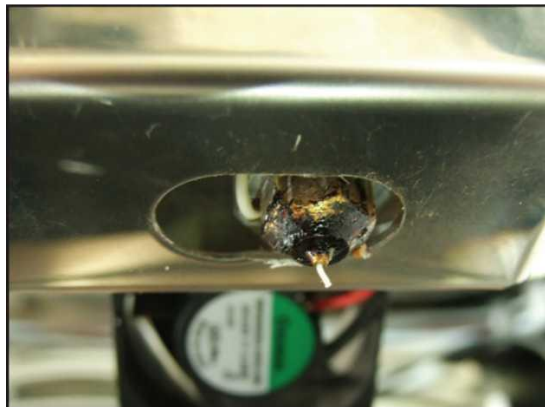

If the material does not flow out from the nozzle faultlessly after the preheating and during the extruder operation, you have to clean the nozzle. But before please proof that the material is pulled faultlessly into the extruder. In order to clean the nozzle, this must be unscrewed from the heating patron unit (corresponding to our instruction) and cleaned for example by the flame of a usual lighter. This can be done by holding the nozzle into the flame of the lighter for example with the help of a pliers until the rests of the plastic are burned away. Afterwards the still remaining impurities from the nozzle can be removed by carefully using a soft wire brush.

For changing the nozzle, the cover has to be disassembled. The nozzle can be loosen by a wrench, while the counterpart must be hold with a tongs. **Please be careful in order not to damage or tear off the cables of the heating patron. Incorrect handling leads to the loss of warranty.**

7.2 Housing

Clean the housing with a dry or slightly wet cloth. Do not use any solvents. Remove the particles from the interior of the printer with a vacuum cleaner.

7.3 Guidings

Wipe the guidings with a lint-free cloth as needed. Grease the guidings regularly with silicon-oil and keep them free of dust and material rests. Do not damage the guidings, because scratches or grooves on them can affect the quality of the print negatively.

8 Problems regarding the print

In the case of problems or failures please contact your dealer or us via the website 'www.3dfactories.com'. There you can find further instructions and support.

In case of enquiry calls please have the serial number of your printer ready.

Use only materials which were released by us, in order to avoid damages.

You can order from your dealer printing materials, accessories and spare parts.

9 Warranty

For private users we offer for this printer a warranty according to the respective country regulations, but at least 12 month. Excluded from the guarantee are consumable materials and wear parts, which are for example:

- toothed belts and toothed belt wheels
- printing bed
- extruder wheels
- bearings
- nozzle and extruder tube

The warranty claim will expire in the case of using not authorized consumable materials and spare parts. The warranty also expires in the case of damages which are caused by neglecting this user manual, as well as in the case of willfully caused damages.

The warranty period for industrial buyers is 12 month.

We explicitly point out that the printing result depends on a lot of factors, as for example the material, the environment and the printing parameters. For this reason a warranty regarding the quality of the printing results cannot be accepted.

10 Disposal notes

This device, which is labeled with the crossed out garbage bin (corresponding to the EU-directive 2002/96/EG "WEE - Waste of Electrical and Electronic Equipment"), should not be disposed in the household garbage.

In this context you can hand over the old printer to a public collecting point of your community respectively of your place of residence (e.g. recycling point).

The device will be disposed there professionally.

By restituting the old device, you contribute substantially to the protection of the environment.

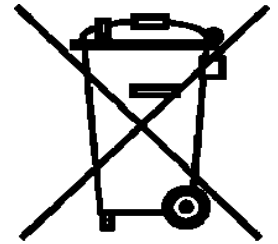

11 Contact details

Manufacturer

3Dfactories
by Adolf Fenz GmbH
John-F.-Kennedy-Str. 1
97877 Wertheim
Germany

www.3dfactories.com